

TR-2200GX

2METER FM TRANSCEIVER

 KENWOOD



OPERATING MANUAL

SECTION 1. PRIOR TO OPERATION

1-1 UNPACKING

After unpacking your TR-2200GX, check to see that the following accessories are included:

1. Dynamic microphone 1
2. 1/4" whip antenna 1
3. Dummy battery 1
4. External speaker plug 1
5. Carrying strap 1
6. Power plug with lead (power cord) 1
7. Battery case (A) (for six batteries, fitted in set) 1
8. Battery case (B) (for four batteries, fitted in set) 1
9. Hook 1
10. Screw, pan head (3 ϕ) 2
11. Battery charger 1
12. Carrying case 1

1-2 BATTERY INSTALLATION

1. Pull the battery snap button at the bottom of the case to open the lid of the battery case (See Fig. 1).
2. When using manganese or alkaline batteries (1.5V per cell), load 9 batteries and the supplied dummy battery into the battery case. The dummy battery may be inserted in any place in the case.
3. When using nickel cadmium (1.2V per cell), load 10 cells into the battery case.

Note 1: When loading, ascertain that the battery polarity is correct; refer to the instructions provided on the battery case.

Note 2: Manganese battery — General type dry battery furnishing a voltage of 1.5V (non-rechargeable).

Alkaline battery — Non-rechargeable battery using caustic potash as electrolyte. It provides better performance than manganese batteries and is interchangeable with a manganese battery.

Nickel cadmium cell — Sealed type rechargeable cell which is also called a Ni-Cd cell.

CONTENTS

SECTION 1. PRIOR TO OPERATION	2
SECTION 2. CONTROLS	4
SECTION 3. OPERATION	6
SECTION 4. HOW TO USE	8
SECTION 5. PRECAUTION	13
BLOCK DIAGRAM	14
SCHEMATIC DIAGRAM	15
SPECIFICATIONS	16

4. Install the loaded battery case into the unit, close the lid and depress the snap button (the battery case should be inserted correctly according to the instructions on the rear of the lid).

1-3 VOLTAGE CHECK

After the loaded battery case has been properly installed in the unit, check the battery voltage according to the procedure below.

1. Set the SQU knob to the "BATT" position by turning it fully counter-clockwise.
2. Turn the power switch (VOL) to the right to set it to ON (the meter pointer will deflect regardless of the ON/OFF positions of the VOL knob).
3. When the meter indication is as shown in Fig. 4 (a), it means that the batteries are weak. Replace all the batteries. In the case of Ni-Cd cells, recharge the cells according to the instructions on page 8.

Note 1: If an external power supply is used instead of internal batteries, the meter will not deflect when the power switch is in the OFF position (when using external power supply, refer to the instructions on page 6).

Note 2: When an external power supply is used, the meter will indicate the voltage of the external power.

Note 3: When checking the voltage of internal batteries using the "BATT" position of the SQU knob, the meter will indicate about 0.2mA of current drain even when the VOL knob is turned OFF. Therefore, the SQU knob should not be left in the "BATT" position when the unit is not in use.

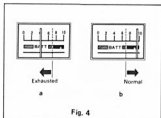
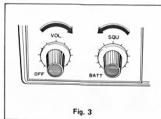
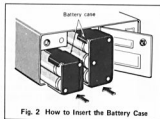
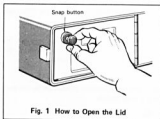

SECTION 2. CONTROLS

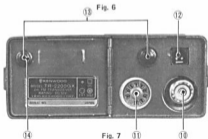
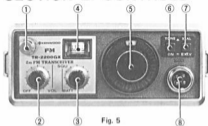

FUNCTIONS OF OPERATING PARTS

- ① WHIP ANTENNA**
When the unit is used as a portable rig, pull out the whip antenna to its full length. The whip antenna can be removed from the unit by unscrewing it to the left. If an external antenna is to be used, do not remove the whip antenna but retract it until it is fully stored in the unit.
- ② VOL Knob**
This knob has two functions; power ON/OFF and receiver volume control. To turn off the power, rotate the knob fully counterclockwise.
- ③ SQU Knob**
This knob also has two functions; battery check and squelch control. To check the power voltage (including battery voltage) or charging voltage, rotate the knob fully counterclockwise. For squelch adjustment, rotate the knob clockwise. The squelch will be ON at about the center position of the turning range.
- ④ Meter**
This meter indicates the strength of receiver input signal (S) and transmitter output signal (RF). It is also used for checking power voltage or charging voltage. The indications of input and output signals are automatically switched when the unit is set in the transmit or receive mode. When checking the power voltage or charging voltage, set the SQU knob to the BATT position.
- ⑤ Channel Selector Knob**
This knob is used to select the desired channel. It turns to both the right and left directions and is calibrated in 12 channels.
- ⑥ Tone Switch**
Depressing this switch makes the signal emitted, modulated by the tone OSC (1.750 Hz), for calling a relay station.

⑦ **XTAL-EXT. V Switch**

This switch selects the internal crystal or the external VFO. Normally it should be used XTAL (Internal crystal) position.

⑧ **MIC Jack**

A microphone connector for the supplied microphone. Press the switch on the microphone and the unit will be set in the transmit mode.

⑨ **External Speaker (or Earphone) Terminal**

For connection of external speaker (or earphone), use the supplied plug.

⑩ **External Antenna Terminal**

An external antenna of 50Ω impedance is connected to this terminal. For connection, use an "M" type receptacle. Refer to Fig. 9.

⑪ **AUX Terminal**

This terminal is used for connection of a center meter. It is also used for remote operation.

⑫ **External Power/Charging Terminal**

Connect an external power supply (DC 13V) with the supplied power cord-plug (DC cord) by referring to Fig. 8. This terminal is also used for charging an alkaline storage battery (See page 8).

⑬ **Case Removing Snap**

To remove the case from the main unit.

⑭ **Battery Removing Snap**

Used to remove the battery.

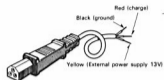

Fig. 8 Power Plug with Lead

Installing UHF Type Connector (PL-259)

- ① Shape the top end of the coaxial cable as illustrated below. Use a sharp single-edged blade being very careful not to damage the center conductor or the braided wire.
- ② Insert the coaxial cable into the coupling, then screw in shaped top end of the cable into the connector body.
- ③ Solder the braided wire and connector body at four soldering holes by the use of a well-kept and clean soldering iron. Make a permanent bond solder being careful not to melt the polyethylene insulation.
- ④ Solder the center conductor.
- ⑤ Using a tester, check the continuity and insulation. Finally move the coupling back on the connector body.

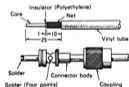

Fig. 9

SECTION 3. OPERATION

3-1 HANDY USE

1. Load the batteries (See "Battery Loading" on page 3).
2. Attach the supplied carrying strap as shown in Fig. 10.
3. The antenna should be fully extended when the unit is in use. Push the antenna down inside the case when it is not in use.
4. Attach the hook as shown in Fig. 10.
5. Insert the connector of the supplied microphone into the microphone jack. The microphone may be hung on the hook.

Note: When the unit is to be moved from one location to another with the antenna left extended, care should be taken not to damage the antenna.

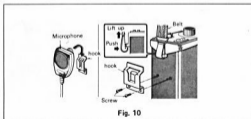

3-2 FIXED STATION USE

1. For fixed station operation, it is recommended that an external power supply be employed, though internal batteries may also be used. The external power supply has an advantage of eliminating the need for checking the power voltage. When using the external power supply, connect it to the unit using the supplied power cord as shown in Fig. 11. The ratings of external power supply should be 13V DC, 0.8A or higher.
2. When using an external antenna, connect it to the external antenna terminal at the rear. The whip antenna on the unit must be fully retracted. (See Fig. 9 for connection of the UHF type connector.)

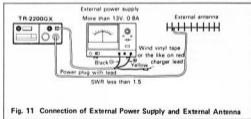

Note: The matching impedance of the antenna and coaxial cable should be 50Ω (RG-8/U, RG-58/U, etc.). Use a low loss coaxial cable, since an antenna cable largely affects the transmit output and receive performance. The antenna system to be used should be of a type of less than 1.5 SWR (standing wave ratio).

To obtain the best SWR, it is preferable that the coaxial cable is of a length for $\lambda/2 \times 0.67$ (λ : wave-length, 0.67: velocity factor of polyethylene coaxial cable) multiplied by an integral number. If the signal-feed element of the antenna is insufficiently protected against rain or humidity, it will result in deterioration of insulation, which, in turn, deteriorates SWR affecting the strength of transmit signals. The signal-feed element should be fully protected using a self-adhesive tape.

3. Mount the microphone hook on the unit as shown in Fig. 10.

Note 1: The voltage of the external power supply should be set to 13V (standard voltage). Do not operate the unit on higher voltages (See Specifications).

Note that a charger used for automobile batteries is not suitable and should not be used as an external power supply.

Note 2: If the unit is to be operated on an external power supply for many hours, remove the internal batteries from the unit.

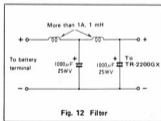

3-3 MOBILE STATION USE

1. For mobile station operation, the unit can be connected to a car battery (12V DC). In this case, use a line filter between the unit and the battery to prevent noise generated from the power system (See Fig. 12). To supply the power from car battery, the unit may be connected to the cigarette lighter socket installed in the car (See Fig. 13).
2. Various types of car antennas are available from most radio shops. Install your car antenna correctly according to the instruction manual included with the antenna.
3. Fix the microphone hook to the unit as shown in Fig. 10.

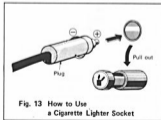

SECTION 4. HOW TO USE

4-1 RECEPTION

1. Check to see that the antenna (whip type or external type) and power (internal or external) connections are correct.
2. Turn the SQU knob counterclockwise to a point just before it clicks into the "BATT" position.
3. Turn the VOL knob clockwise and the power is turned to ON. Turn this knob further clockwise until noise can be heard and set it for suitable loudness.
4. Set the channel knob to "A" (145.50 MHz). If a signal is received, the meter will deflect and the sound will be heard from the speaker (the meter indicates the strength of the input signal).
5. To eliminate the noise which is heard while no signal is being received, slowly turn the SQU knob clockwise and set it where the noise disappears (threshold point). This setting should be made with the channel knob set to a channel receiving no signals.
The SQU knob should be adjusted properly according to the strength of input signals.

4-2 TRANSMISSION

1. Check the antenna and the power supply for correct connection as in the case of reception. When the whip antenna is used, be sure that it is fully extended.
2. Check that the microphone is plugged into the unit.
3. Set the channel knob to the desired channel.
4. Depress the PTT-switch on the microphone. The unit is now set to the transmit mode and the pointer of the meter (RF) will swing. While depressing the PTT-switch, speak into the microphone and your voice will be transmitted. Hold the microphone about 5 ~ 10 cm from your mouth.

Note: The meter (RF) is factory adjusted so that it reads "7 ~ 9" in the transmit mode, when the antenna impedance is 50Ω. Use the meter as a rough check of antenna SWR or transmitter output.

5. The unit may be used to call a repeater station. The built-in channel "R6" or "R8" has a frequency shift of 600 kHz between the trans-

mit and receive frequencies.

When calling a repeater station controlled by a carrier frequency, do not press the tone switch.

For a repeater station controlled by a tone, press the tone switch; a signal tone modulated by 1750 Hz is transmitted while the tone switch is being pressed.

4-3 BATTERY CHARGING

Check the battery voltage (See page 3) before charging. The batteries should be recharged before the battery voltage is reduced to 9V (between red and black zones of meter). The unit is equipped with special terminals for charging nickel cadmium batteries. To charge the batteries, use the supplied battery charger as shown in Fig. 14.

To check the batteries for proper charging, use the white marking in the black zone of the BATT indicator as an easy guide (See Fig. 15). Continue charging until the meter reads in the white region.

The time required for the batteries to be fully charged is about 15 hours. When the batteries are charged for the first time, it is recommended that they be charged for about 20 hours.

Note 1: Do not attempt to continue charging after the batteries have been fully charged. The batteries should be charged at temperatures of $0^{\circ}\text{C} \sim 45^{\circ}\text{C}$.

Note 2: Never try to charge normal type dry batteries or alkaline dry batteries, since they are not designed to be recharged. If charged, a gas will be developed which causes explosion of the batteries, resulting in damage to the unit.

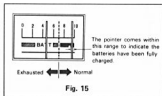
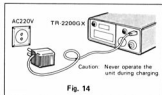

4.4 COMPARISON BETWEEN MANGANESE BATTERY AND ALKALINE STORAGE CELL

When the voltage of an alkaline storage cell decreases to 1.0V or less, the energy of the cell is reduced to less than 1/10 of the initial value, and therefore the cell must be charged.

Fully charged nickel cadmium cells will last for more than 2 hours when used at the rate of 1 minute transmission and 3 minutes reception (See Fig. 16), while manganese batteries last for about 40 minutes (See Fig. 17). Accordingly, it is advisable to use nickel cadmium cells from the standpoints of the performance of the unit and the service life of batteries. Nickel cadmium cells have very low internal resistance and are subject to generation of heat when they are shorted or connected in wrong polarity, resulting in damage to the cells. Due care should be exercised when using nickel cadmium cells.

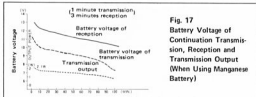
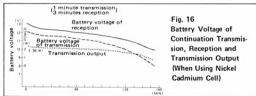

4-5 AUX TERMINAL

The AUX terminal is wired as shown in Fig. 18.

1. Use this terminal as a center meter terminal. Connect a center meter to the #9 and #4 pins of the AUX terminal.
2. The AUX terminal may also be used as an external standby terminal. Connect an external switch to the #6 and #4 pins of the AUX terminal.
3. For other usage of the AUX terminal, use the #5 pin (COM 13V) of the terminal for controlling an added circuit.
4. An external VFO (VFO-30G) can be connected to this connector, using the interconnecting cord provided with the VFO-30G. In this case the XTAL-EXT. V switch should be set to EXT. V position. This switch is immediately accessed from any channel on the channel selector knob by depressing the XTAL-EXT. V switch. In this case, the current flowing through the pin should be kept at 10mA or less.

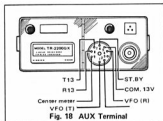

4-6 EXT. SP TERMINAL

If you desire to use an external speaker, use the supplied plug. The speaker should be rated at 8-ohm impedance. Care must be taken not to short the output circuit because it uses the OTL system. Fig. 19 (a) shows the method of connecting the speaker plug. When using a headphone, it should be connected through a 47 Ω resistor as shown in Fig. 19 (b).

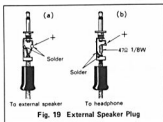

4-7 CONSTRUCTION OF CHANNELS

In channel R6, R8 and A, crystals are provided as tabulated below. Other channels are empty channels. If expansion of channels is required, refer to 4-8 CRYSTAL CORRELATION.

Channel	Transmit freq. (MHz)	Receive freq. (MHz)
R6	145.15	145.75
R8	145.20	145.80
A	145.50	145.50

Table 1 Channel Numbers and Frequencies

Channel	R1	R2	R3	R4	R5	R6	R7	R8	R9	A	B	C
Plastic cover indication	1	2	3	4	5	6	7	8	9	10	11	12

Table 2 Channel Numbers and Plastic Cover Indication

4-8 CRYSTAL CORRELATION

To install additional channels, proceed as follows: Pull the snap button on the bottom of the case and then remove the case (See Fig. 20).

Next, remove the two sliding pieces as shown in Fig. 21 and take off the plastic cover.

Install additional crystals for the transmitter and receiver confirming their positions according to the instructions shown on the plastic cover. Make sure that they are correctly installed. The elements for transmitter are marked "T" and those for receiver marked "R". The oscillating frequencies of these elements can be obtained from the following equations:

$$\text{Transmit frequency (MHz)} = \frac{\text{Desired transmit frequency}}{12}$$

$$\text{Receive frequency (MHz)} = \frac{\text{Desired receive frequency} - 10.7}{3}$$

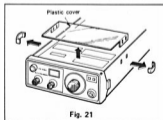
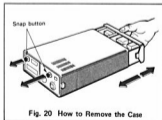

4-9 FREQUENCY ADJUSTMENT

The frequency of any additional channel must be adjusted correctly after the crystal elements have been installed. The standard type receiver crystals designed exclusively for this unit require no adjustment. Use of any other types of crystals may result in a different frequency.

1. Adjusting with frequency counter

The frequency counter to be used should be capable of measuring frequencies up to about 150 MHz or more.

1) Receiver section (Frequency confirmation only)

Connect the frequency counter as shown in Fig. 22.

$$\text{Counter frequency} = \text{Channel frequency (MHz)} - 10.7 \text{ (MHz)}$$

2) Transmitter section (Adjust precisely with trimmer)

Connect the frequency counter as shown in Fig. 23 and set the unit in the transmit mode. The frequency on the counter can be obtained from the following:

$$\text{Counter frequency} = \text{Channel frequency}$$

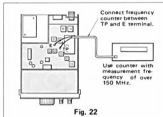

2. When frequency counter is not available.

The crystals for use in the TR-2200GX can be adjusted for approximate frequencies at the center position of the trimmers.

Adjustment of transmit frequency

With the unit set to the receive frequency of your party's station, have the party receive your transmit signal. Adjust the trimmer of the transmitter section so that the signal can be heard most clearly or the center meter of the party's station indicates about "0" point.

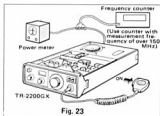

SECTION 5. PRECAUTION

5-1 GROUNDING SYSTEM

The unit uses a negative grounding system. Care should be exercised when connecting an external power supply.

5-2 OPERATION IN LOW TEMPERATURE AREAS

The unit is designed to provide optimum performance when used in areas of $-20^{\circ}\text{C} \sim +50^{\circ}\text{C}$ of temperatures. However, if it is to be operated in areas of -20°C , use a protective bag to cover the unit for protection of the internal batteries. Do not use conventional manganese dry batteries for operation in areas of 0°C or lower temperature, as it will deteriorate the performance of the batteries. Use of nickel cadmium cells is recommended.

BLOCK DIAGRAM

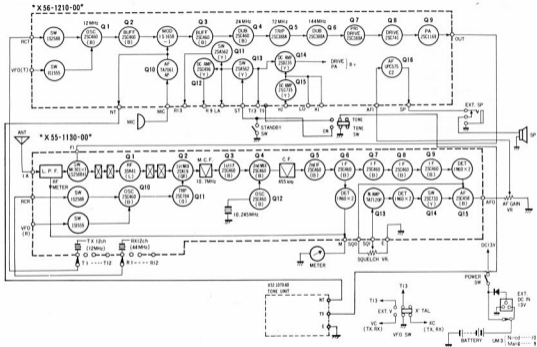

SCHEMATIC DIAGRAM

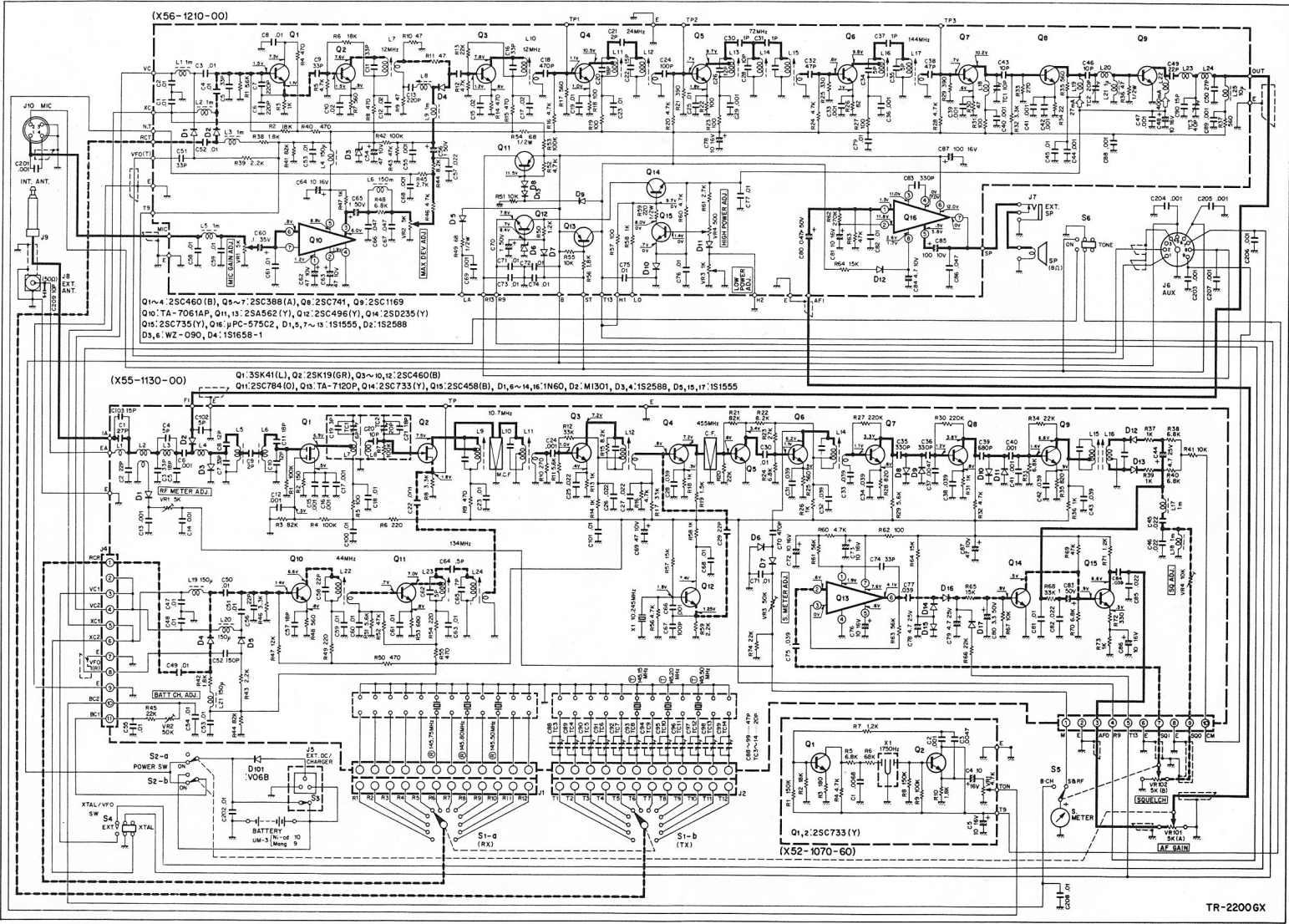

SPECIFICATIONS

GENERAL

Frequency Range	144 to 146 MHz	
Channels	12 channels	
Built-in Channels	3 channels	
	Transmit	Receive
	145.15 MHz	145.75 MHz
	145.20 MHz	145.80 MHz
	145.50 MHz	145.50 MHz
Operating Voltage	9.6 to 15.6V DC (13.8V DC nominal)	
Operating Temperature	-20 to +50°C	
Grounding	Negative grounding	
Antenna Impedance	50 Ω	
Current Drain		
Receive	Approx. 45 mA (No signal)	
Transmit	Approx. 700 mA	
Dimensions	5-5/16" (135 mm)	Wide
	2-9/32" (58 mm)	High
	7-33/64" (191 mm)	Deep
Weight	Approx. 1.6 kg, 3.52 lbs. (Nickel-Cadmium battery cells 10 included.)	
Semiconductors	Transistors	28
	FETs	2
	ICs	3
	Diodes	31

TRANSMIT

RF Output Power	2 watts
Modulation	F3 (phase modulation)
Crystal Multiplication	12 times
Deviation	\pm 5 kHz maximum
Spurious and Harmonics	Less than -60 dB below carrier
Microphone	Dynamic microphone with PTT switch, 500 Ω

RECEIVE

Circuitry	Double superheterodyne
Intermediate Frequency	10.7 MHz (1st IF) 455 kHz (2nd IF)
Sensitivity	Less than 1 μ V for 30 dB S/N
20 dB Noise Quieting	Less than 0.4 μ V
Squish Sensitivity	Less than 0.25 μ V
Pass Band Width	More than 16 kHz (at -6 dB)
Selectivity	Less than 32 kHz (at -60 dB)
Audio Output (at 8 Ω)	More than 0.7 W
10% Distortion	

* The above specifications are subject to change without for improvement.



A product of
TRIO-KENWOOD CORPORATION

6-17, 3-chome, Aobadai, Meguro-ku, Tokyo 153, Japan